

UL 28 - 12

12V 28AH

STANDBY

Ultrace//[®]

'Quality in Every Language'

Image



Terminal Type

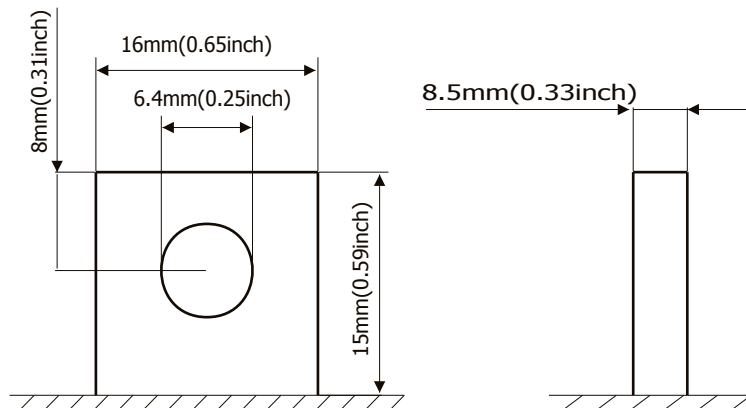

Dimensions

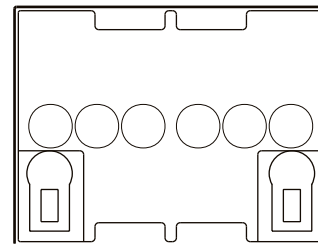
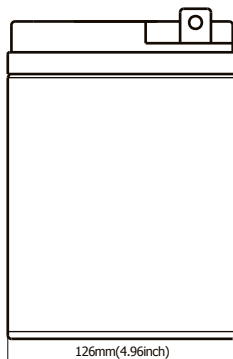
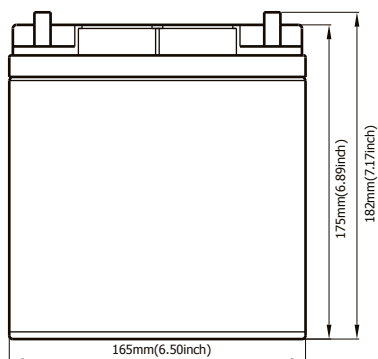

Specifications

Battery Model	UL 28 - 12			
Designed Floating Life	8 Years			
Capacity (25°C)	20HR (1.4A, 1.75V)	10HR (2.66A, 1.75V)	5HR (4.76A, 1.75V)	1HR (16.8A, 1.55V)
	28AH	26.6AH	23.8AH	16.8AH
Dimensions	Length	Width	Height	Total Height
	165mm	126mm	175mm	182mm
Approx. Weight	8.7Kg			
Internal Resistance	Fully Charged at 25°C 0.01 Ohm			
Self Discharge	3% of capacity declined per month at 25°C			
Capacity Affected by Temperature	40°C	25°C	0°C	-15°C
	102%	100%	85%	65%
Charge Voltage (25°C)	Cycle Use		Float Use	
	14.0 - 15.0V (-24mV/C), max. Current: 8.4A		13.6 - 13.8V (-18mV/C)	

Construction

Component	Raw material	Sealant	Epoxy Resin
Positive	Lead dioxide	Safety Valve	EPDR
Negative	Lead	Terminal	Copper
Container	ABS (Flame Retardant optional)	Separator	Fibre Glass
Cover	ABS (Flame Retardant optional)	Electrolyte	Sulphuric acid
Sealed and maintenance free option		Non-spillable construction design	

UL 28 - 12

12V 28AH

STANDBY

Ultrace//[®]

'Quality in Every Language'

Charge Characteristic

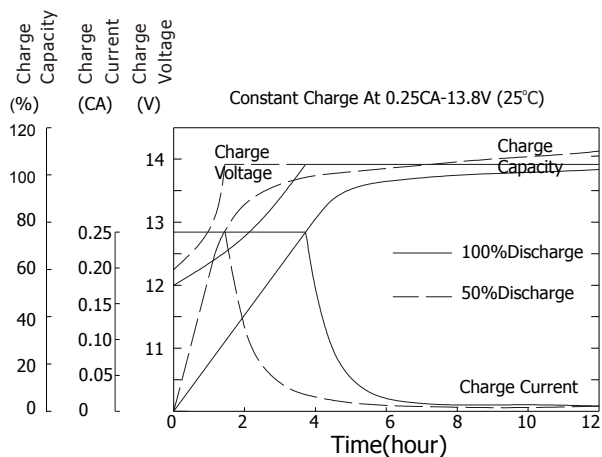

Discharge Characteristic 25°C

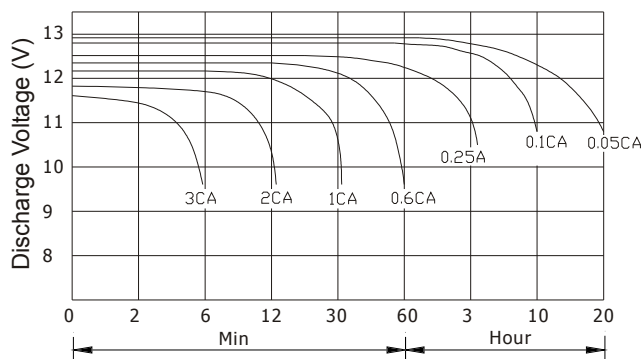

Relationship of OCV and state of charge

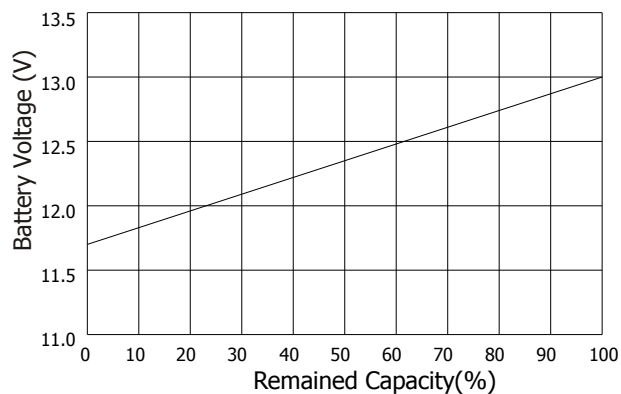

Self Discharge Characteristics

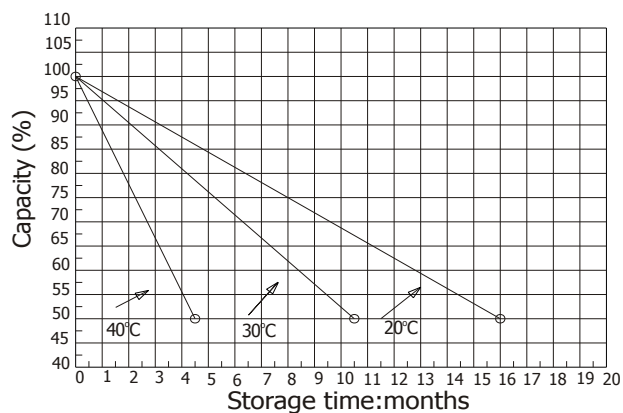

Constant Current Discharge Ratings - amperes at 25°C

F.V / Time	5 MIN	10 MIN	15 MIN	30 MIN	1 HR	3 HR	5 HR	10 HR	20 HR
1.60 V	110.3	67.76	51.35	31.30	16.85	8.73	5.15	2.85	1.56
1.67 V	102.5	64.96	49.78	30.02	16.63	7.39	5.04	2.80	1.51
1.70 V	89.50	62.16	48.22	27.22	16.01	7.12	4.92	2.74	1.51
1.75 V	93.52	60.48	46.65	25.93	15.68	6.83	4.79	2.69	1.46
1.80 V	82.88	57.68	42.39	24.02	16.62	6.66	4.70	2.64	1.41
1.85 V	73.36	54.77	37.97	22.01	14.15	6.55	4.70	2.21	1.35

Constant Power Discharge Ratings - watts at 25°C

F.V / Time	5 MIN	10 MIN	15 MIN	30 MIN	1 HR	3 HR	5 HR	10 HR	20 HR
1.60 V	224.0	145.6	112.0	64.96	36.4	14.2	9.63	5.43	2.86
1.67 V	216.7	142.2	110.3	63.84	36.0	14.1	9.58	5.43	2.86
1.70 V	207.8	140.0	107.5	62.72	35.6	14.0	9.57	5.38	2.80
1.75 V	195.4	134.4	104.2	61.04	35.1	13.9	9.53	5.38	2.80
1.80 V	169.7	124.3	99.68	59.36	33.9	13.6	9.42	5.26	2.74
1.85 V	160.2	115.4	95.20	56.56	33.2	13.4	9.31	5.26	2.74